



The principle of clarity: HANSAMATRIX

The concealed installation system for freedom of design, consistent shapes and efficient installation.

The system that provides clarity. In front of the wall and also behind it. HANSAMATRIX.

Today, bathrooms are living spaces that reflect the lifestyle and the personality of their owners. At the same time, the demands placed on the design of these modern bathrooms increase. Architecture-oriented bathroom planning takes the entire room into account, and designing it in a comprehensive and harmonious way becomes extremely important. The overall impression is created through the division of surfaces, while harmony is achieved through the balanced proportioning and clear structure of these. The look of the fittings is crucial in this regard.

We have developed HANSAMATRIX to respond to the need of implementing a high-quality architecture-oriented planning environment as a completely concealed installation solution. HANSAMATRIX is a modular and highly flexible product system. The components can be combined in an unexpectedly great variety using a grid with classical proportions. This results in an individual and at the same time puristic look of the fittings with an always uniform logic at the basin, bath and shower.



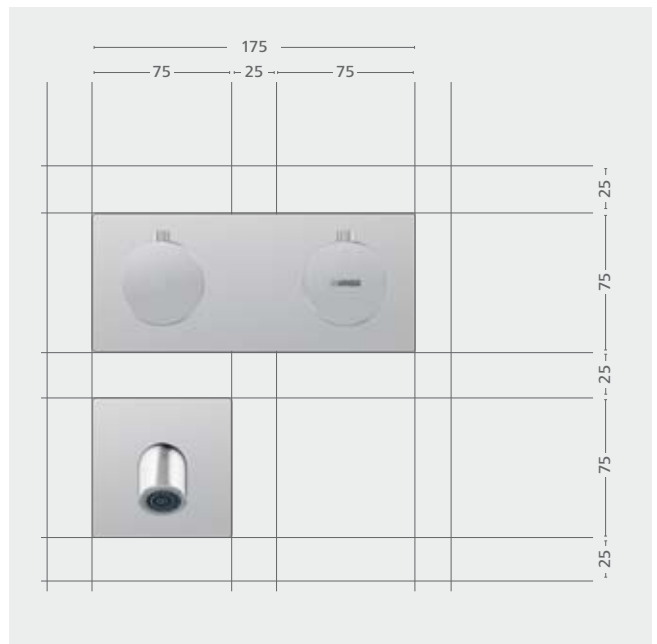

Defined and clear: With HANSA **MATRIX**, the measure of all things is 25 mm. Based on a 25-mm grid, surfaces can be divided in a well-balanced manner, can be designed in good proportions and can be optimally utilised. Thanks to the clear logic, the designer has maximum possible freedom.

For the design, two classical shapes are derived from the grid dimension: a square measuring 75 mm x 75 mm and a precise rectangle measuring 75 mm x 175 mm.

HANSAMATRIX fitting designs: Linear, puristic, stringent – in the entire bathroom.

Thanks to its modular structure, the HANSAMATRIX system is flexible, planning-oriented and fulfils very different individual demands. As the concealed installation units can be designed completely flexibly, a previously unknown freedom in the arrangement of the individual components can be achieved: Almost everything that the customer desires can be implemented.

The components can be combined at the basin, bath and shower almost without restriction. Since various functions can purposefully be combined in a new component, the fittings have a calm and neat look. Throughout the room, they are based on the same principle, namely: the fine 25-mm grid. Its overall impression with its straight lines, stringency and clarity is very attractive.

- 1 Consistently reduced to achieve the maximum effect: a HANSAMATRIX solution at the basin with a puristic rectangular trim kit in the 75 x 175 mm grid format.
- 2 Typically HANSAMATRIX: Turning the components will create a double basin that is optimised for left and right-handed people.
- 3 The bath clearly shows the new design options offered by HANSAMATRIX: The combination of many functions in only a few components allows for solutions that are both complete and compact while creating a clear and clean look.

- 4 One of the benefits offered by HANSAMATRIX is in the fact that even large surfaces can be optimally structured and designed. In this solution for the shower, all elements are arranged based on the 25-mm grid. This creates a minimalistic and completely harmonious look of the fittings – harmonious in themselves, in respect of all other fitting designs of the bathroom and in respect of the look-and-feel of the entire room.



HANSAMATRIX bathroom planning and execution: Just as structured and safe as the entire system.

Integrating the entire room in the planning places increased demands on the bathroom designer. But regardless of how complex your planning is: HANSAMATRIX is designed to ensure that you can safely reach your target while allowing for the implementation even of unusual customer requests.

Starting with the idea sketches, the surfaces in the room where products are to be positioned are divided.
For example, the wall to be used for a shower installation is defined and structured using the HANSAMATRIX grid.
The fine grid dimension and the continuous logic provide you with extreme flexibility in the process.

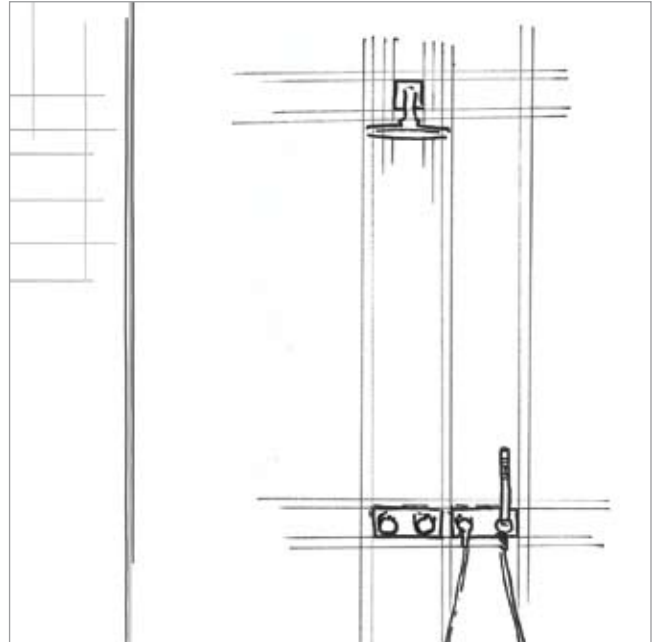

Once the desired product functions have been defined (for example a thermostat with diverter for overhead shower and shower holder), all of the necessary HANSAMATRIX exposed and concealed installation products are selected and arranged on the wall surfaces in accordance with the grid. Special mounting rails assist with the accurate alignment and installation of the concealed installation units.



The grid can be transferred 1:1 to the final installation. Both in front of and behind the wall, the components take up the grid dimensions and the system of HANSAMATRIX.



HANSAMATRIX range:

Clear structure and an unbelievable number of possible combinations.

Installation and planning level

The mounting rails guarantee compliance with the grid during installation. They can be precisely joined both horizontally and vertically. The points of installation correspond exactly to the 25-mm planning grid.

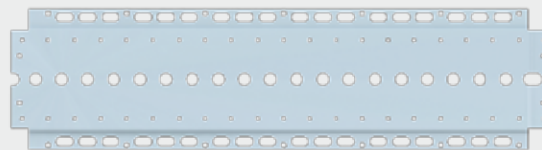

Concealed installation and functional level

Compact and effective components that have already been preassembled and tested ensure perfect installation. They work with the safe and functional concealed installation technique from HANSA that fulfils the highest demands.

Function units for single-lever mixers for basin, bath or shower

available with shut-off valve (1) or with diverter / shut-off valve (2)

Single-lever mixer (1)

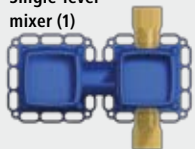

Single-lever mixer (2)

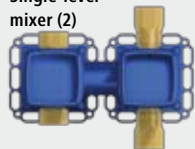

Function units for thermostats for bath or shower

available with shut-off valve (1) or with diverter / shut-off valve (2)

Thermostat (1)



Thermostat (2)



Wall outlet function unit for bath or shower

Outlet

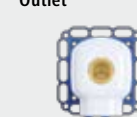

Accessories

can be used without concealed installation unit,

Exposed installation and design level

The desired trim kits – HANSADESIGNO is shown as an example here – are selected based on the previously defined functions and function combinations for basin, bath or shower. They offer you maximum flexibility.

Various lever mixer versions for basin, bath or shower

Single-lever mixer basin



Single-lever mixer with diverter



Various thermostat versions for bath or shower

Thermostat with shut-off valve



Thermostat with shut-off valve and diverter



Various wall outlet versions

Spout



Wall outlet



Shower holder



Single-lever mixer + wall outlet



Over-head shower



Shower rail

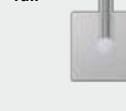

Wall outlet + shower rail



Wall outlet + shower holder



HANSAMATRIX technology: HANSA quality even behind the wall.

Right from its early days, HANSA has aimed to supply the best quality in the market. And for us, quality is never just something apparent, superficial, merely restricted to the appearance. In line with this philosophy, HANSAMATRIX is an integrated system that is just as well-thought-through, precise and structured behind the wall as it is in front of the wall.

Technology and functionality, reliability and durability of the concealed installation units determine the quality of the entire installation. When developing HANSAMATRIX, we therefore focussed on innovative and pragmatic solutions that make it possible for you to implement the highest demands in a simple, efficient and safe manner.

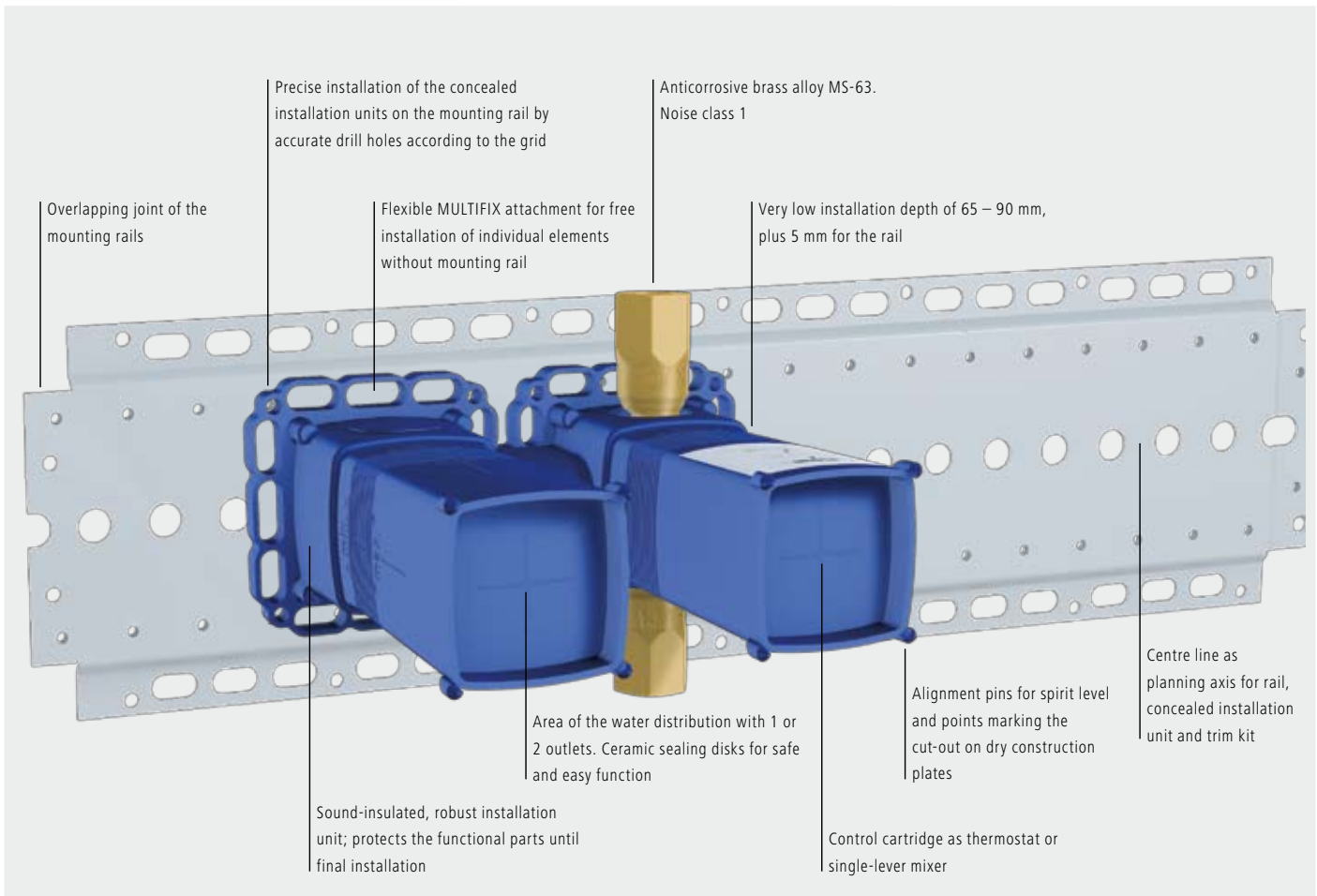

The lever mixer

- HANSA 3.5 control cartridge
- Hot water stop



- Striking format
- Precise shape
- High-quality look

The thermostat

- One of the smallest installation sizes available in the market
- High flow rate capacity of 25 l/min
- Thermal disinfection possible

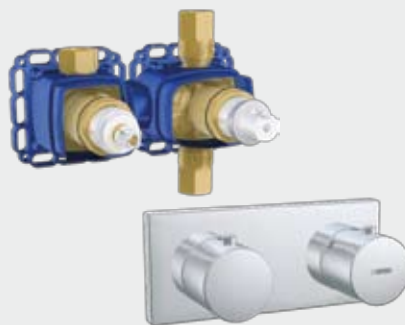

- Modular, symmetrical structure
- Same shapes at the bath and the shower

The wall outlet

- Insulated unit
- Standard 1/2" outlet
- Free 90° positioning



- Minimum rosette size
- Diverse solutions for the wall outlet
- Innovative combination of functions

HANSAMATRIX product packages: Complete planning with 2 product numbers for the first time.

With HANSAMATRIX, complex concealed installations cannot only be planned in a clear, structured and dimensionally accurate manner – also the execution is very easy and safe.

To make everything as easy as possible for you, we have already prepared some product pictures and the corresponding product packages. These packages include tried-and-tested product combinations of different scopes; all are complete, but can naturally also be changed as desired.

If your planning corresponds to one of the suggested product pictures, your HANSAMATRIX planning will be complete with just 2 product numbers: The first product number includes the trim kits with design and function, the second product number the corresponding concealed installation package comprising mixer, wall outlet and mounting rail. The type and number of the two is always adapted to each other.

You wish to adapt or extend the product packages?

Not a problem: You plan your own product pictures, and we will supply the HANSAMATRIX elements for implementing these. You can freely combine or extend products from the matching HANSAMATRIX exposed and concealed installation units and the required number of mounting rails.

Shower (single-lever mixer or thermostat)

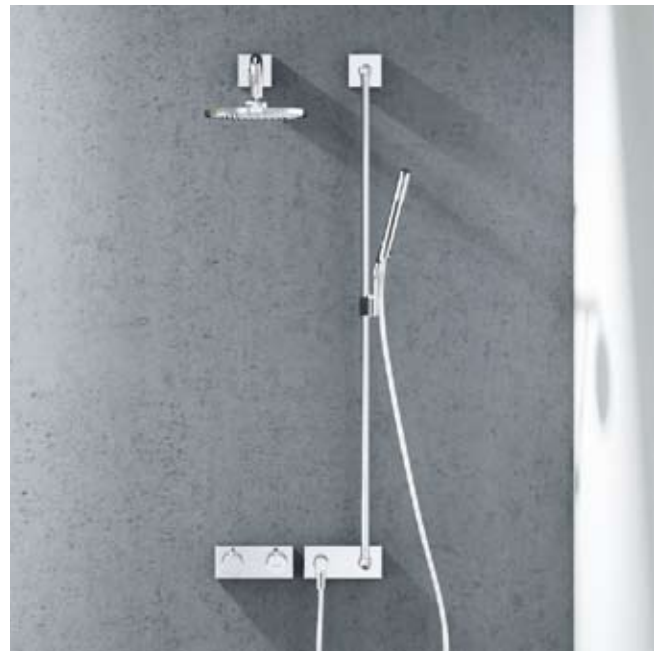

Bath (single-lever mixer or thermostat)



Basin (single-lever mixer)





Single-lever mixer product pictures

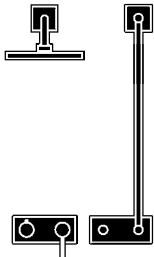

Exposed installation package 03
4487 0030

Concealed installation package 01
4486 0010



Exposed installation package 04
4487 0040

Concealed installation package 01
4486 0010



Exposed installation package 01
4487 0010

Concealed installation unit
4400 0000



Exposed installation package 02
4487 0020

Concealed installation unit
4400 0000

The product kits for the shower differ in volume and complexity. The option to choose between lever mixer and thermostat results in differences in terms of comfort. Additionally, a choice between overhead and hand shower is possible.

Thermostat product pictures

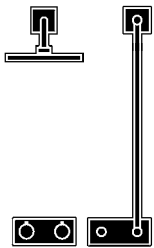

Exposed installation package 07
4487 0070

Concealed installation package 04
4486 0040



Exposed installation package 08
4487 0080

Concealed installation package 04
4486 0040

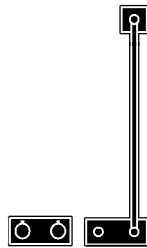

Exposed installation package 05
4487 0050

Concealed installation package 03
4486 0030



Exposed installation package 06
4487 0060

Concealed installation package 03
4486 0030

Single-lever mixer product pictures

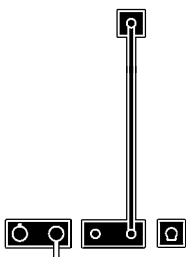

Exposed installation package 09
4487 0090

Concealed installation package 02
4486 0020

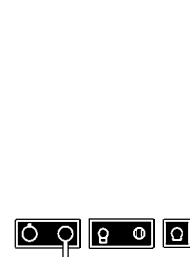

Exposed installation package 10
4487 0100

Concealed installation package 02
4486 0020

Thermostat product pictures

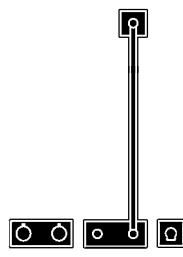

Exposed installation package 11
4487 0110

Concealed installation package 05
4486 0050



Exposed installation package 12
4487 0120

Concealed installation package 05
4486 0050

The product kits for the bath differ in volume and complexity. Differences result primarily from the choice between lever mixer or thermostat and the choice between shower rail and shower holder.



Exposed installation product
5109 2173

Concealed installation product
4400 0000



2 x exposed installation product
4487 0120

2 x concealed installation product
4400 0000

Rail(s) according to requirement
4405 0000

At the basin, the easiest way is to create complete product pictures from the individual products. For double basins, you should additionally order the required number of mounting rails – depending on the width of the basin.

HANSAMATRIX
installation system



Basin package solutions



Single-lever mixer trim kit
Wall-mounted mixer, suitable for HANSADESIGNO, DN 15
5109 2173 chrome,
5109 2177 chrome
Lever with glass inlay, black,
5109 2178 chrome
Lever with glass inlay, white,
projection: 200 mm,
plus concealed installation unit 4400



Concealed installation unit, DN 15 (G1/2) single-lever mixer
4400 0000, outlet to the front

Bath/shower package solutions



Single-lever mixer complete installation package 09
4487 0090 chrome, suitable for HANSADESIGNO with wall bar kit with bath spout, DN 15 plus concealed installation unit 4486 0020



Single-lever mixer complete installation package 10
4487 0100 chrome, suitable for HANSADESIGNO with shower kit with bath spout, DN 15 plus concealed installation unit 4486 0020

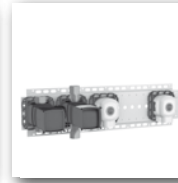

Single-lever mixer concealed installation package 02
4486 0020, for 2 wall outlets

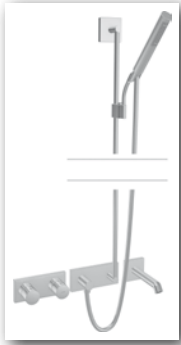

Thermostat complete installation package 12
4487 0120 chrome, with shower kit with bath spout, DN 15 plus concealed installation unit 4486 0050

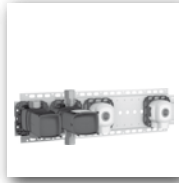

Thermostat concealed installation package 05
4486 0050, for 2 wall outlets

Thermostat complete installation package 11
4487 0110 chrome, with wall bar kit with bath spout, DN 15 plus concealed installation unit 4486 0050

Shower package solutions

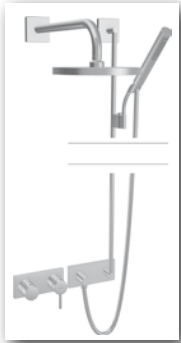

Single-lever mixer complete installation package 03
4487 0030 chrome, suitable for HANSADESIGNO with wall bar kit with HANSARAIN overhead shower, DN 15 plus concealed body 4486 0010



Single-lever mixer complete installation package 04
4487 0040 chrome, suitable for HANSADESIGNO with shower kit with HANSARAIN overhead shower, DN 15 plus concealed body 4486 0010

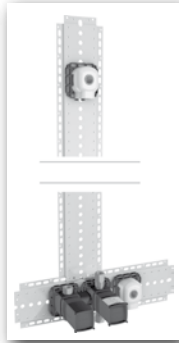

Single-lever mixer concealed installation package 01
4486 0010, for 2 wall outlets



Single-lever mixer complete installation package 01
4487 0010 chrome, suitable for HANSADESIGNO with all-metal wall bar 1100 mm plus concealed installation unit 4400



Single-lever mixer complete installation package 02
4487 0020 chrome, suitable for HANSADESIGNO with wall-mounted shower holder plus concealed installation unit 4400



Concealed installation unit, DN 15 (G1/2) single-lever mixer
4400 0000, outlet to the front

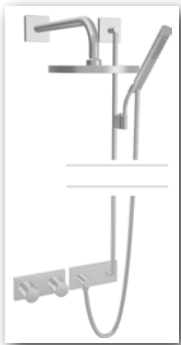

Thermostat complete installation package 07
4487 0070 chrome, with wall bar kit with HANSARAIN overhead shower, DN 15 plus concealed body 4486 0040



Thermostat complete installation package 08
4487 0080 chrome, with shower kit with HANSARAIN overhead shower, DN 15 plus concealed body 4486 0040

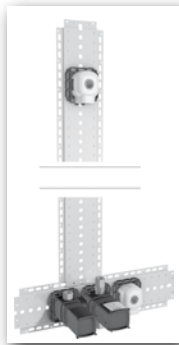

Thermostat concealed installation package 04
4486 0040, for 2 wall outlets

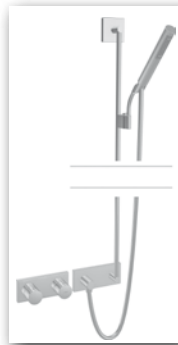

Thermostat complete installation package 05
4487 0050 chrome, with wall bar kit plus concealed body 4486 0030



Thermostat complete installation package 06
4487 0060 chrome, with shower kit plus concealed body 4486 0030

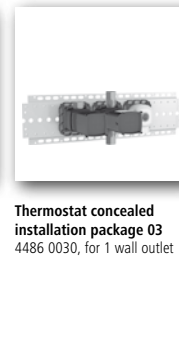

Thermostat concealed installation package 03
4486 0030, for 1 wall outlet

Individual components



Trim kit wall-mounted single-lever basin mixer, suitable for HANSADESIGNO, DN 15

5109 2173 chrome,
5109 2177 chrome,
lever with glass inlay, black,
5109 2178 chrome,
lever with glass inlay, white,
for wall installation
Projection: 200 mm
plus concealed installation
unit 4400



Trim kit single-lever mixer, suitable for HANSADESIGNO
4450 9503 chrome,
outlet to the front
plus concealed installation
unit 4400



Concealed installation unit, DN 15 (G1/2) single-lever mixer
4400 0000,
outlet to the front



Trim kit single-lever mixer, suitable for HANSADESIGNO
4451 9503 chrome,
with 2-way diverter
plus concealed installation
unit 4401



Concealed installation unit, DN 15 (G1/2) single-lever mixer
4401 0000,
with 2-way diverter



Trim kit thermostat mixer
4452 9503 chrome,
with shut-off valve,
plus concealed installation
unit 4402



Concealed installation unit, DN 15 (G1/2) thermostat mixer
4402 0000,
with shut-off valve

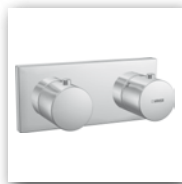

Trim kit thermostat mixer
4453 9503 chrome,
with 2-way diverter,
plus concealed installation
unit 4403



Concealed installation unit, DN 15 (G1/2) thermostat mixer
4403 0000,
with 2-way diverter



Wall bar kit 1100 mm
4442 0100 chrome,
with wall connection elbow
plus concealed installation
unit 4404



Shower kit
4443 0100 chrome, with wall
connection elbow,
plus concealed body 4404



Overhead shower, DIN 15
0418 0300 chrome, suitable
for HANSADESIGNO,
can be combined with
HANSAMATRIX,
projection: 400 mm
plus concealed installation
unit 4404



Bath spout, DN 15
5116 2170 chrome,
can be combined with
HANSAMATRIX
projection: 200 mm
plus concealed installation
unit 4404



Concealed installation unit, DN 15 (G1/2) connecting angle
4404 0000

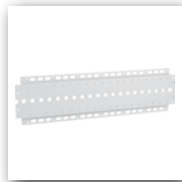

Mounting rail
4405 0000, for precise and
easy installation of the
concealed installation units



Solid-metal wall bar
4441 0100 chrome,
1100 mm (can be shortened),
Ø 18 mm
can be combined with
HANSAMATRIX



Wall-mounted shower holder
4444 0100 chrome,
can be combined with
HANSAMATRIX



The right product for the modular and design-oriented concealed installation system HANSAMATRIX.



Consumes up to 60% less water and energy*.
Designed for thermostats with quick temperature-adjustment times.



Extremely quiet. Fitting complies with the strict requirements of noise class 1.



Our thermostats offer maximum safety with protection against scalding.



Thermostat is suitable for thermal disinfection.
This is particularly important for public or large-scale facilities.

Please note:

The shown and dimensioned exposed installation product packages show tried-and-tested product combinations in an exemplary way in the smallest possible grid arrangement. This must be adapted to the actual planning situation. The packages include all HANSA products required for complete installation.

The concealed installation product packages include all HANSA products that you require for the installation of the dimensioned and shown combinations (without pipes, fittings, fasteners).

For a different arrangement of the package elements please check the requirement for mounting rail 4405. For the complete installation, you always require the matching concealed installation and trim kit product packages or individual components.

* in comparison to a conventional two-handle mixer.

Head Office

Hansa Metallwerke AG
Sigmaringer Str. 107
70567 Stuttgart
Tel.: +49 (0)711 1614-0
Fax: +49 (0)711 1614-368

www.hansa.com